

PRESSURE REGULATORS

High-Purity

Brass High-Purity Two-Stage Models



Y12-N245 series

Design Features

Encapsulated Filter Seat Assy

for added gas stream purity and extended service life.

Convuluted Stainless Steel Diaphragms

provide superior leak integrity without contamination from a non-metallic liner or seal.

Bonnet Vent Ports (with optional bonnet vent adaptors)

allow venting of hazardous gases in the event of diaphragm failure.

Metal to Metal Seal for High Purity

Standard Threaded Bonnet (with optional collar-mount nuts) for easy panel mounting.

Diaphragm Packless Valve (with 1/4" Compression fitting)

promotes system purity.

Six Outlet Pressure Ranges

provide application pressure compatibility.

Panel Mount Bonnets

front and rear.

Description: This series of two-stage, high-purity regulators is designed for non-corrosive analytical and process applications requiring precise, stable, delivery pressure control. The two-stage design yields a delivery pressure of less than 0.02/100 psi inlet change.

These regulators come with a CGA nipple that has a special high-purity, nonlubricated check valve incorporated into nose and prevents air and contaminants from entering the gas stream during cylinder change out. This creates consistencies in processes and extends column life in GC applications. This regulator also has both a front and rear panel mount bonnet to allow for easy panel mounting.

Convuluted stainless steel diaphragms with metal to metal seals provide excellent regulating characteristics and allow for internal vacuum purging. The metal-to-metal diaphragm seal prevents con tamination by eliminating the need for a soft seal and provides a leak-rate design of less than 2×10^{-8} ccs helium. This minimizes cleanup time in vacuum purging and yields lower residual contaminant levels.

A diaphragm packless outlet valve with a 1/4" compression fitting is provided for flow control and to maintain system purity. Captured bonnet ports with optional vent adaptors are standard on both stages and allow for the venting of hazardous gases in the event of diaphragm failure. These regulators are ultrasonic ally cleaned for the most demanding high-purity service.

Specifications	
Maximum Rated Inlet Pressure	3,500 psig
Outlet Pressure Ranges	0-25, 0-50, 0-100, 0-150, 0-250, 0-500 psig
Flow Capacity	Cv = 0.1
Ambient Operating Temperature	-40° F to +165° F
Designed Leak Rate	2×10^{-8} ccs (helium)
Weight	5.2 lbs
Ports (5)	1/4" FNPT
Inlet	1/4" FNPT
Outlet	1/4" Compression
Decay Inlet Characteristic	0.02/100 psi

Materials	
Body	Nickel-Plated Brass
Bonnet	Nickel-Plated Brass
Seat	PTFE
Diaphragm	316 Stainless Steel
Gauges	2 1/2" Nickel-Plated Brass
Filter	316 Stainless Steel
Outlet Valve	Nickel-Plated Brass
Trim	Nickel-Plated Brass

Ordering Information

Product Number	Material	Max Inlet Pressure (psig)	Max Outlet Pressure (psig)	Capacity (scfh @ Max Del. Pressure)	Inlet Gauge Range (psig)	Delivery Gauge Range (psig)
Y12-N245A(CGA)	Brass	3,500	25	190	0-4,000	30" Hg-0-30
Y12-N245B(CGA)	Brass	3,500	50	270	0-4,000	0-60
Y12-N245D(CGA)	Brass	3,500	100	380	0-4,000	0-200
Y12-N245E(CGA)	Brass	3,500	150	525	0-4,000	0-200
Y12-N245F(CGA)	Brass	3,500	250	850	0-4,000	0-400
Y12-N245G(CGA)	Brass	3,500	500	1000	0-4,000	0-1,000

Available Options

Product Number	Description
Y99-CHROMNUT	Panel Mounting Nut
Y99-BONNETADP	Bonnet Vent Adaptor
Y99-4VCR	1/4" VCR connection on Inlet/Outlet (VCR x 1/4" MNPT)
Y15-QMB1	Quick Mounting Option for 1 Cylinder
Y15-QMB2	Quick Mounting Option for 2 Cylinders

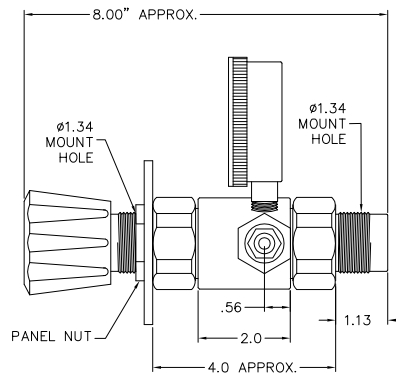
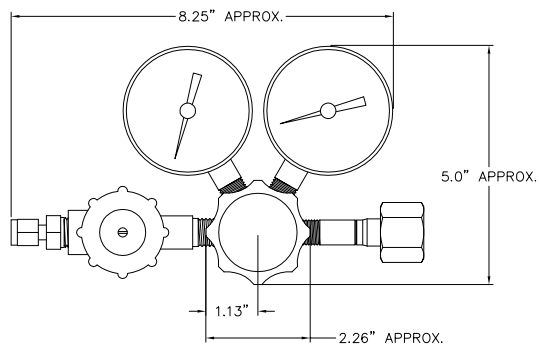
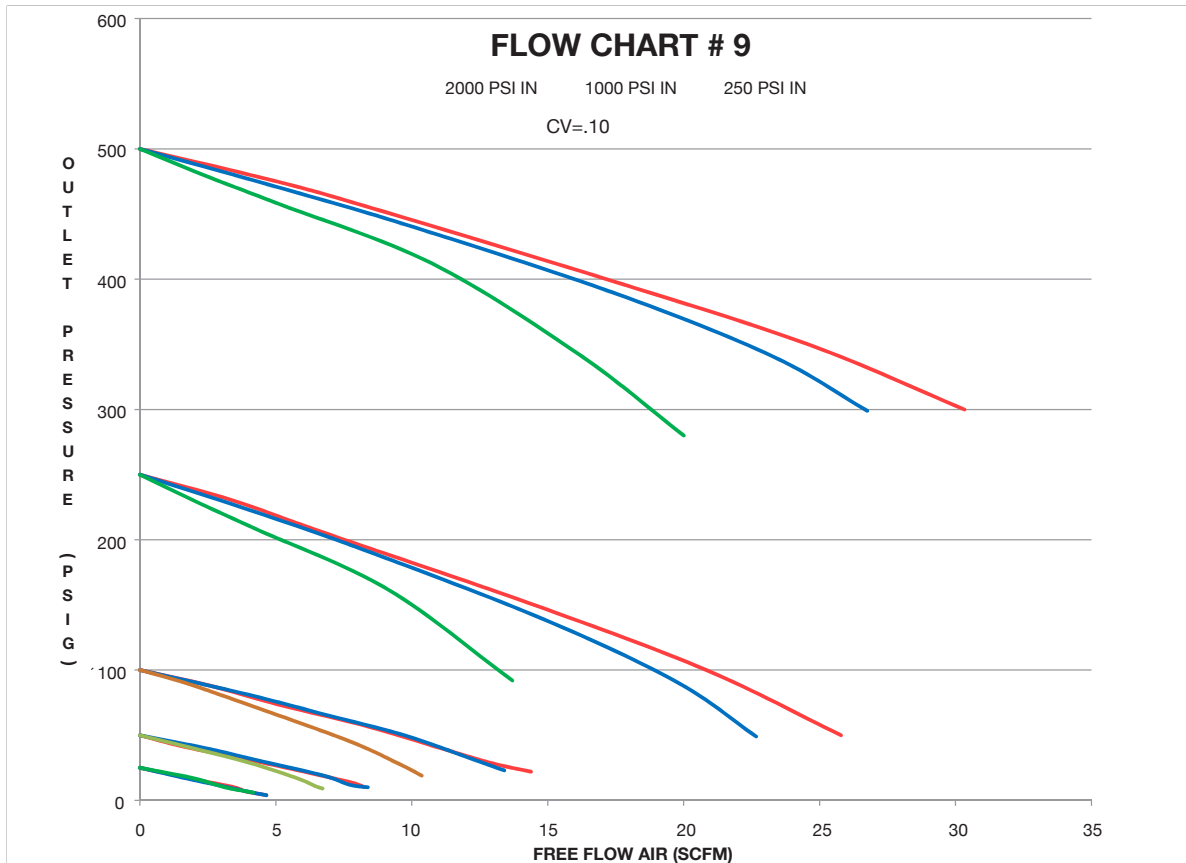

TWO STAGE REGULATOR

